















STUDIO PROGRAMMA

ARCH. CLAUDIO CALCINAI - ARCH. VALTER PIERI
Viale Rimembranza n.15 - 50060 Pelago (FI) - Tel. (Fax) 055/8326276

LA PROPRIETA'	PROGETTO:	23
	VARIANTE AL PUE - (PROGETTO URBANISTICO ESECUTIVO CONVENZIONATO) - AMBITO 5.1 - VIA TOGLIATTI - PER LA REALIZZAZIONE DI ALLOGGI DI EDILIZIA PRIVATA	
IL PROGETTISTA	UBICAZIONE: Comune di Pelago - Loc. Paterno - Via Togliatti RICHIEDENTE: EDILCIESE srl - VANNINI	
	OGGETTO:	1:200
	Planimetria verde pubblico	

PLANIMETRIA DEL VERDE PUBBLICO

LEGENDA

-  Recinzione con rete metallica plastificata H = mt. 1,20
-  Quote di progetto
-  Lampione su palo H 4,50 mt.
-  Fontanella in ghisa
-  Pavimentazione con tappeto emulsione di resina colorata spessore cm. 3.00
-  Cestino rivestito di legno
-  Panchina in legno
-  Prato Manto erboso misto (margherite nane, dicondra, trifoglio nano ecc.)
-  Alberature di basso fusto (olivo, oleandro, alberi da frutto ecc.) (Da concordare al momento della messa in posa con l' U. T. C.)
-  Siepe sempreverde e cespugli (alloro, lauro, mista mediterranea con lavanda, biancospino, ecc.)
-  Delimitazione area verde pubblico
-  A.Q. Attrezzatura di quartiere
-  V.P.A. Verde pubblico attrezzato
-  V.P.S. Verde pubblico secondario

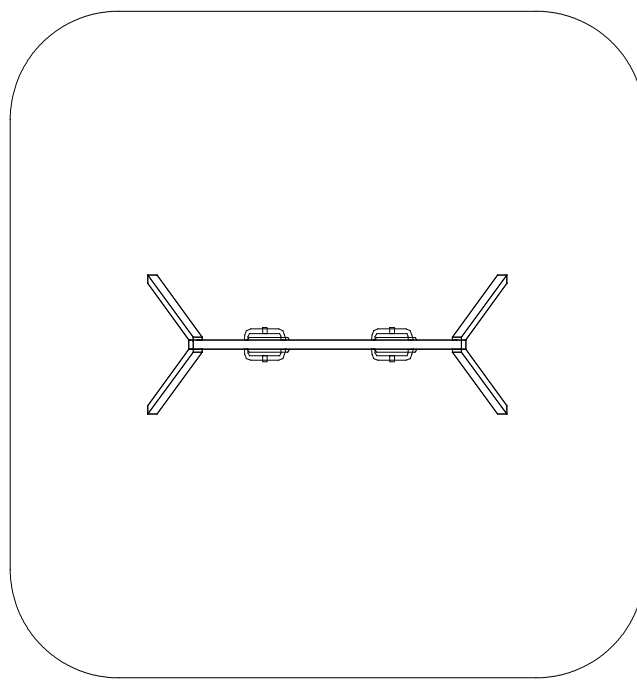

Altalena doppia 202
Vedi modello Ditta Fantoni

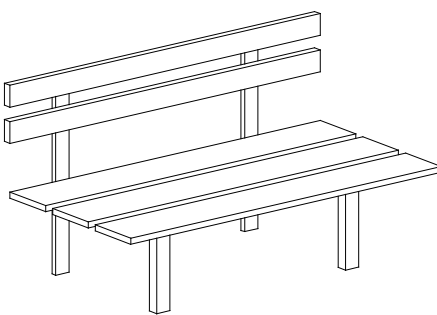

Panchina in legno
Vedi modello ANDRIA Ditta Fantoni

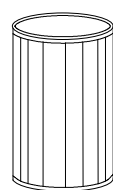

Cestino legno con anello
Vedi modello ANDRIA Ditta Fantoni

