

STUDIO PROGRAMMA

ARCH. CLAUDIO CALCINA - ARCH. VALTER PIERI
 Viale Rimenbranza n.15 - 60060 Pelago (FI) - Tel. (Fax) 055/8326276

LA PROPRIETA' PROGETTO:
 VARIANTE AL P.U.E. - (PROGETTO URBANISTICO ESECUTIVO
 CONVENZIONATO) - AMBITO 5.1 - VIA TOGLIATTI - PER LA REALIZZAZIONE
 DI ALLOGGI DI EDILIZIA PRIVATA

15

UBICAZIONE: Comune di Pelago - Loc. Palermo - Via Togliatti
 RICHIEDENTE: EDILCIESSE srl - VANNINI

IL PROGETTISTA
 OGGETTO: Sezioni Stradali
 1:200

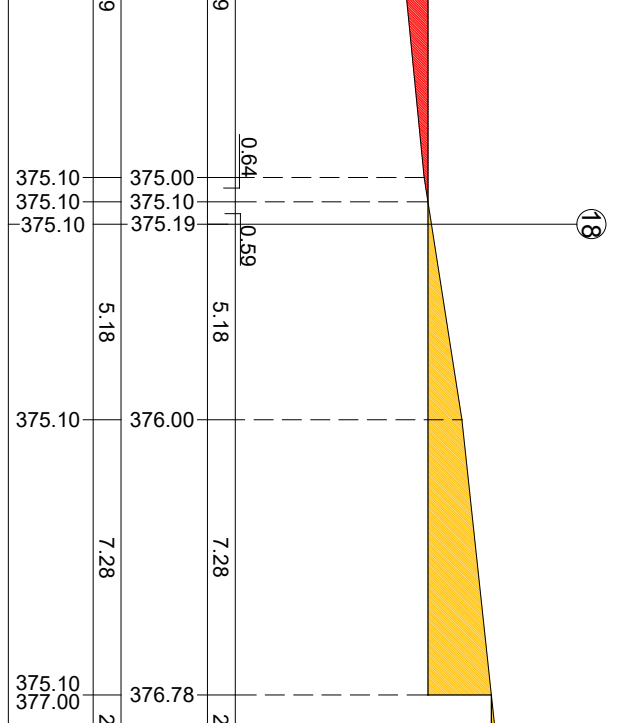
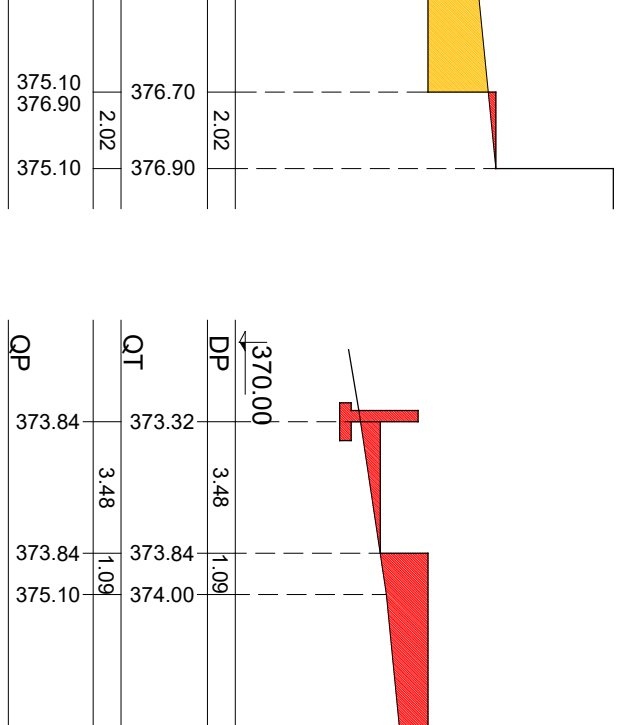
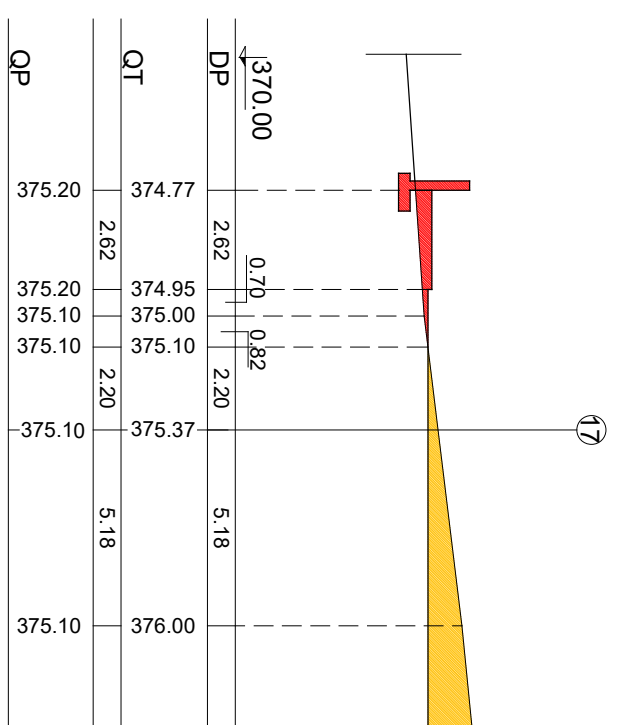
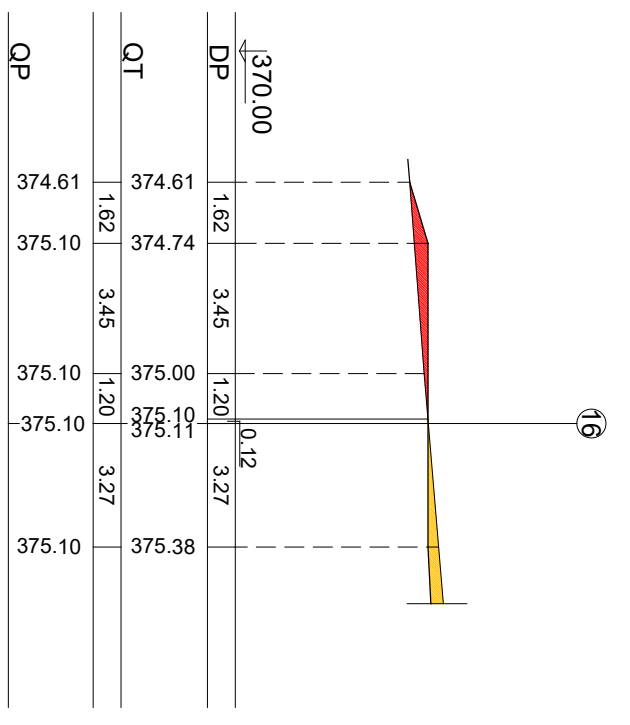
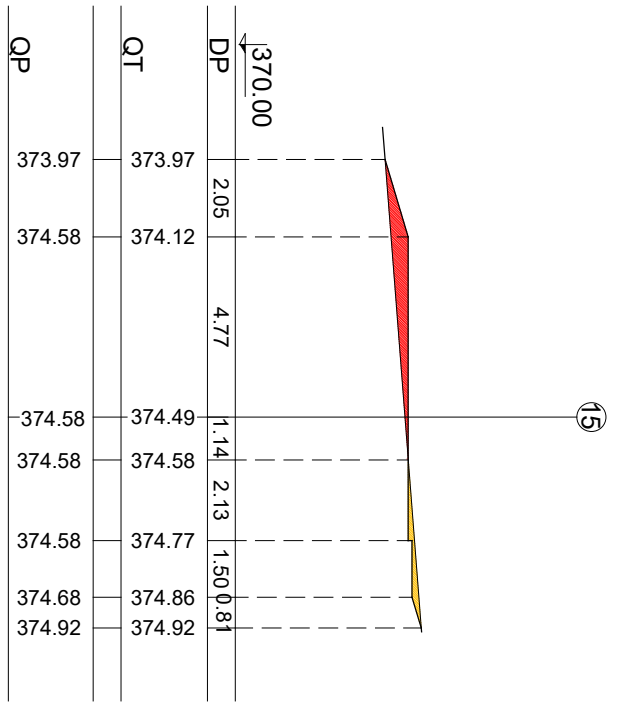
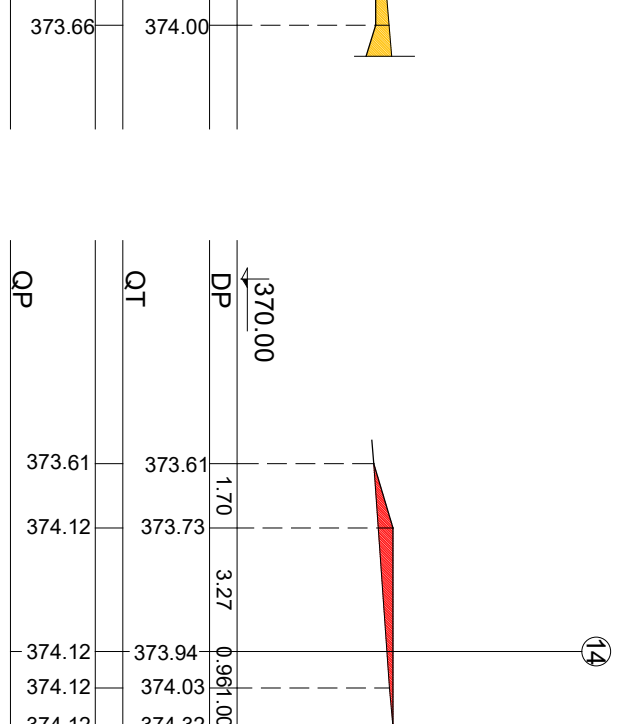
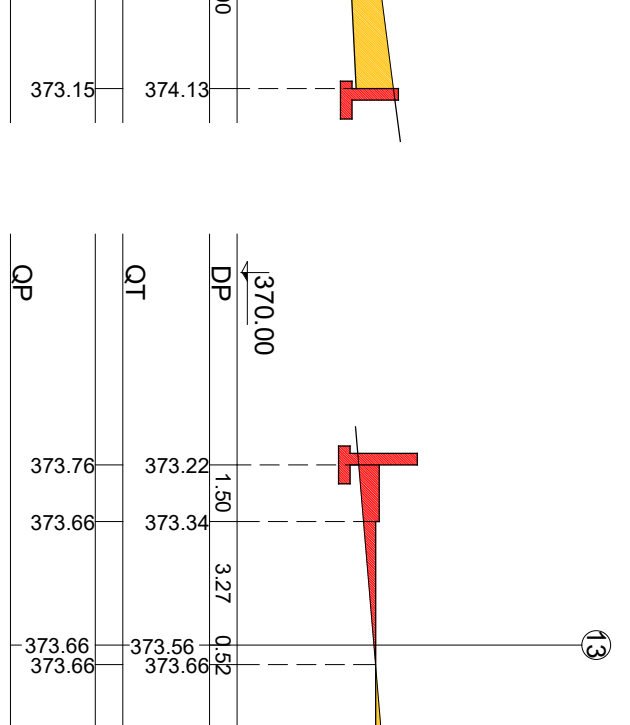
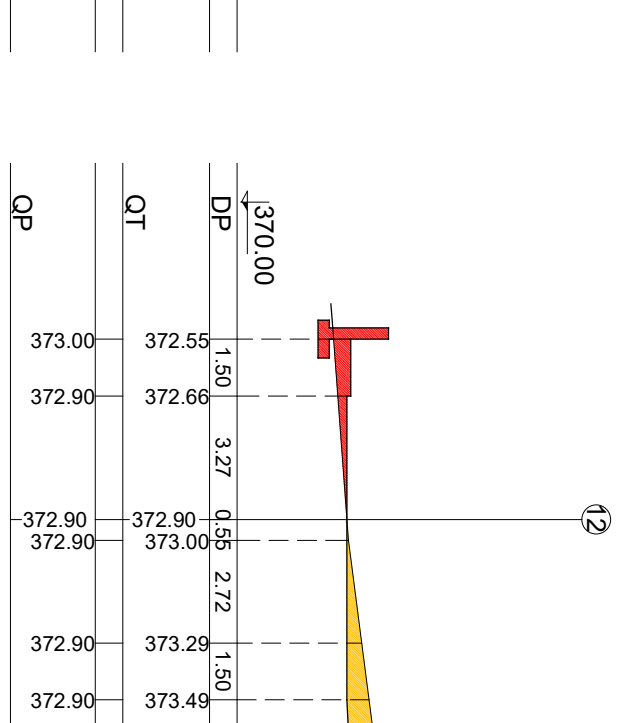
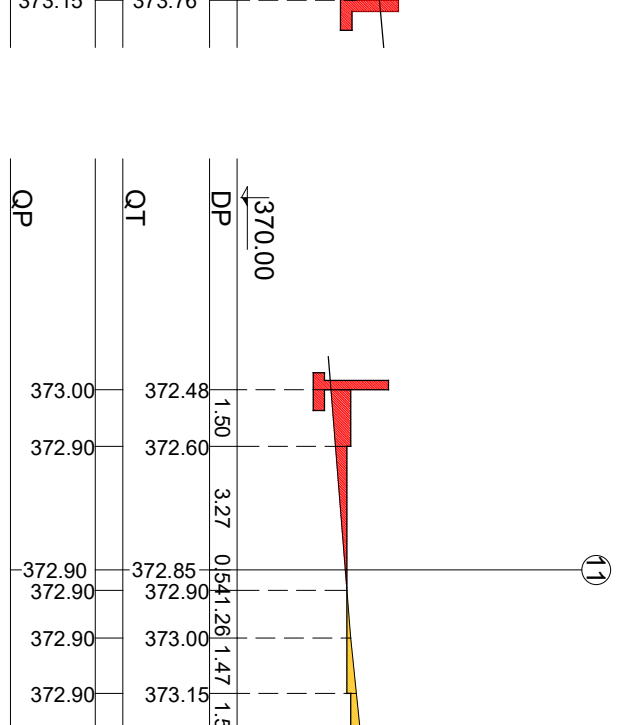
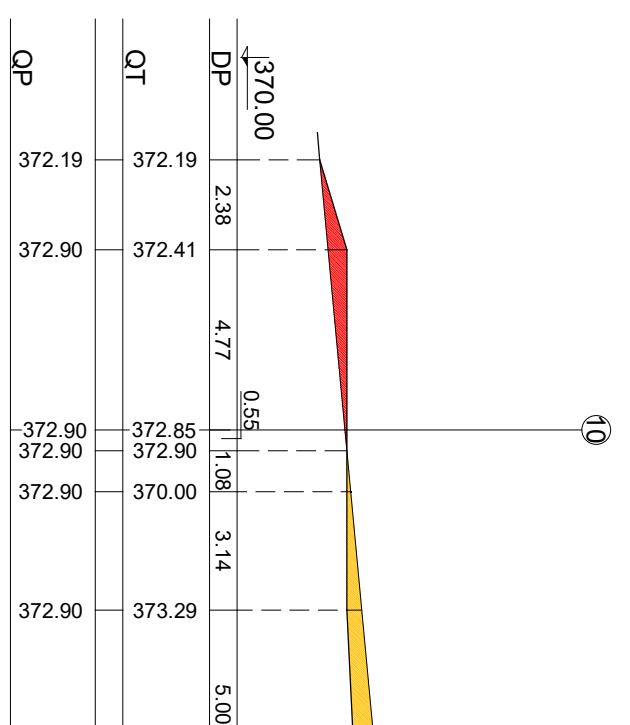
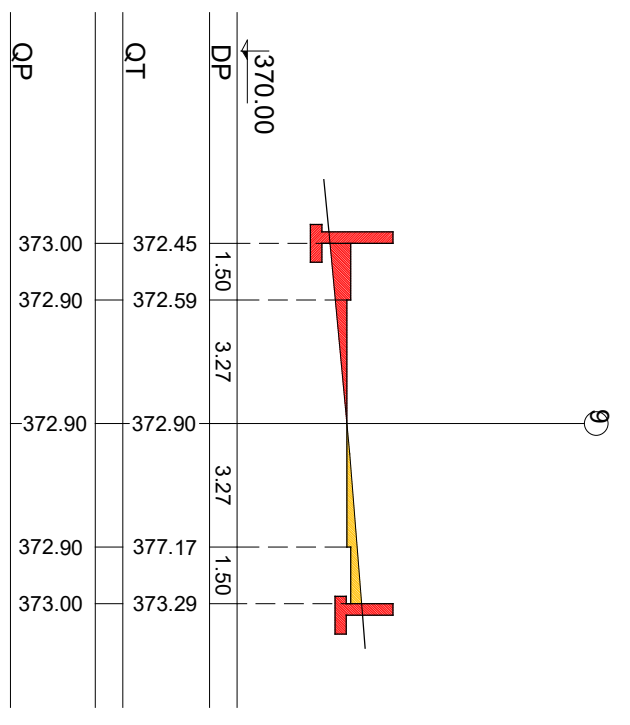
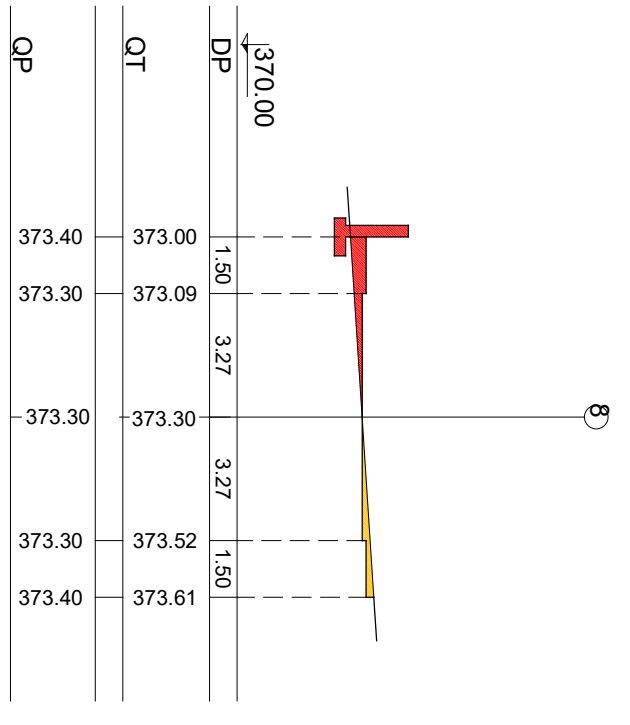
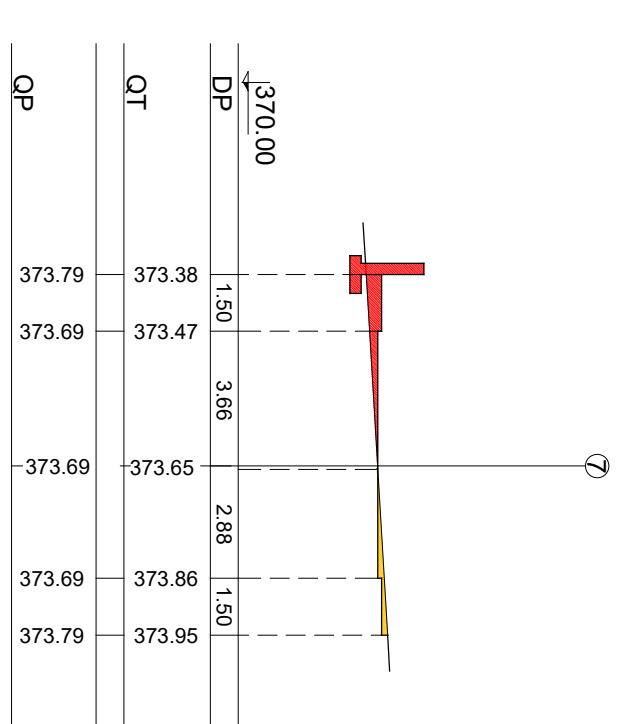
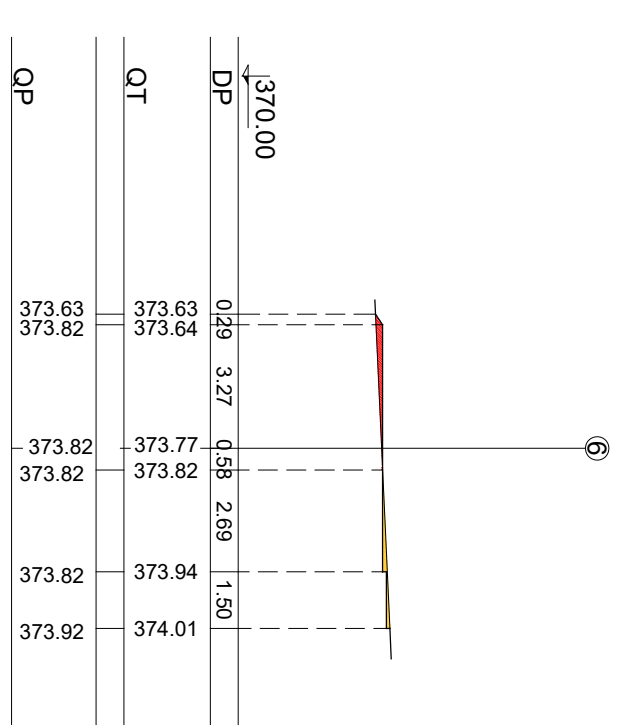
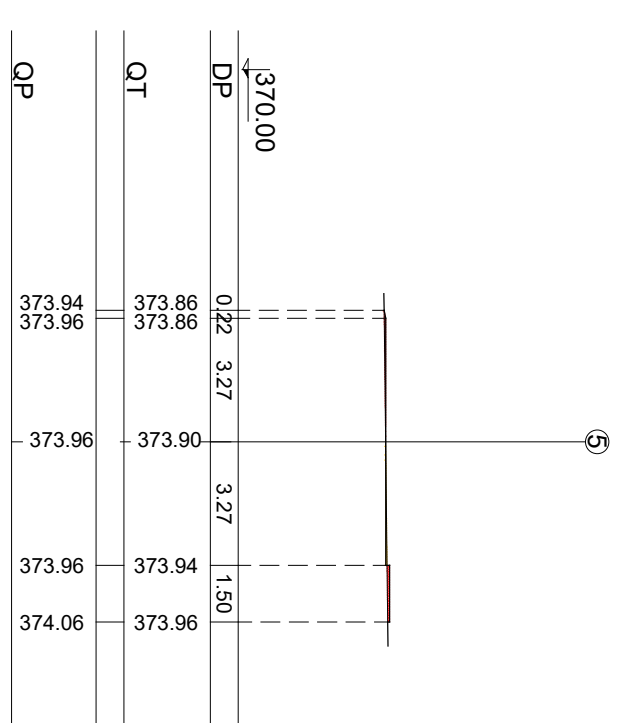
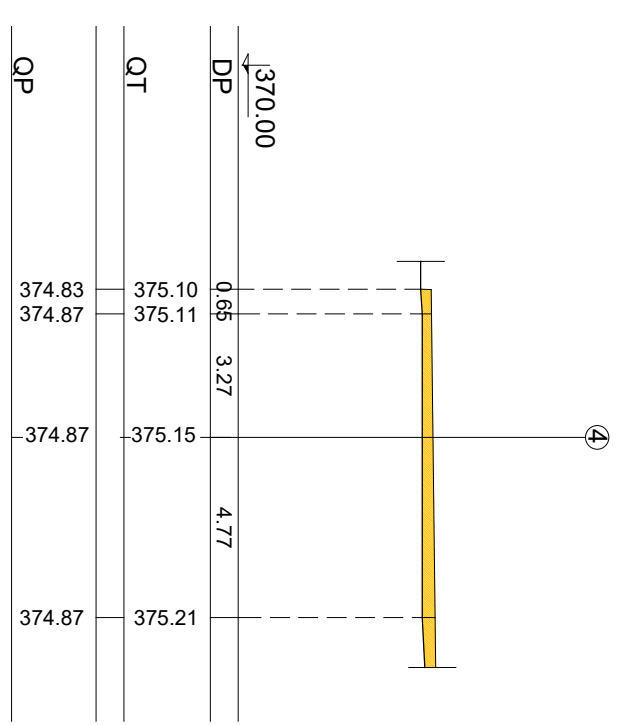
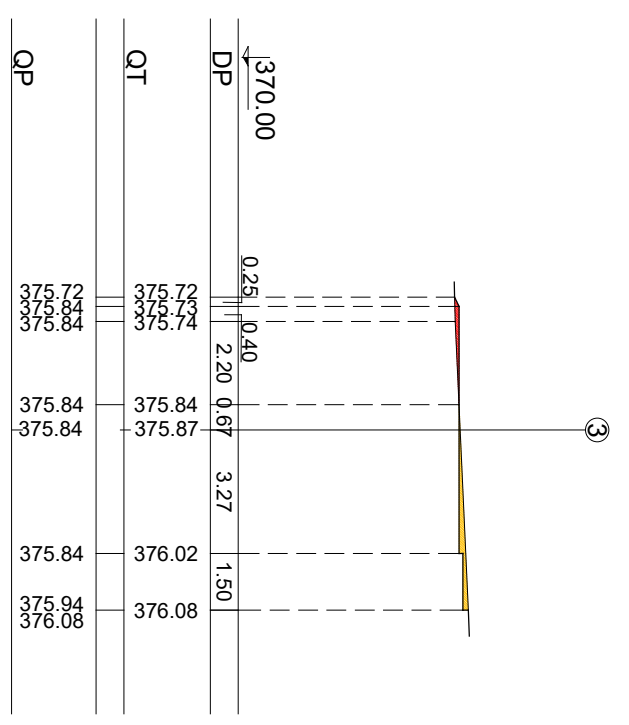
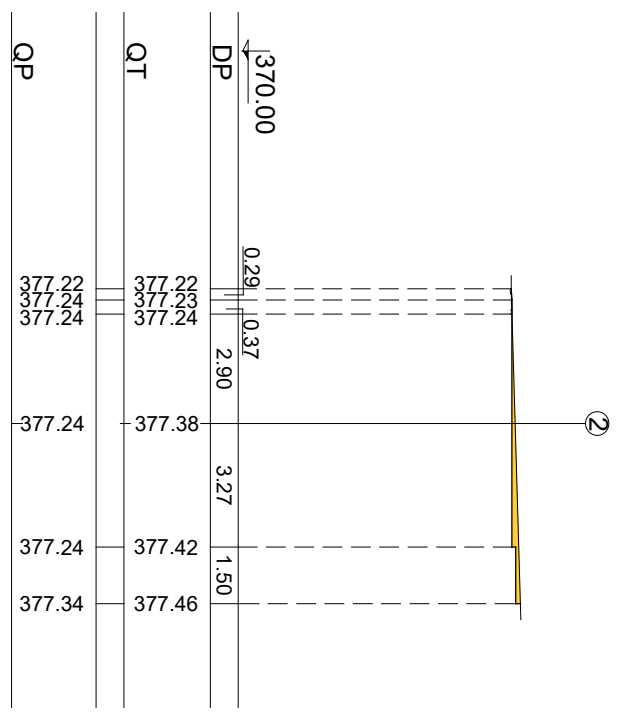
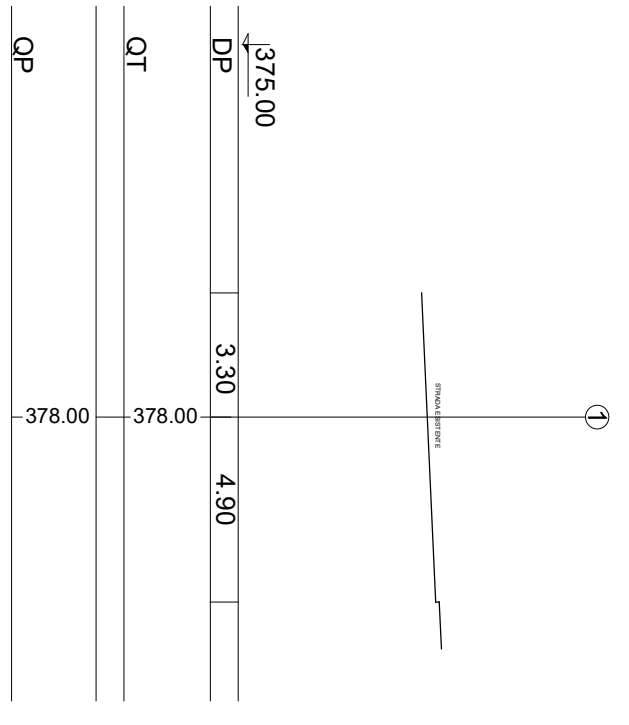

SEZIONI STRADALI
 1:200